

**PCFY-P-VKM-E**

1. SPECIFICATIONS .....	1 - 172
2. EXTERNAL DIMENSIONS .....	1 - 173
3. CENTER OF GRAVITY .....	1 - 176
4. ELECTRICAL WIRING DIAGRAMS .....	1 - 177
5. SOUND LEVELS .....	1 - 178
5-1. Sound levels .....	1 - 178
5-2. NC curves .....	1 - 178
6. OA INTAKE-STATIC PRESSURE CURVES .....	1 - 179
7. TEMPERATURE/AIRFLOW DISTRIBUTIONS .....	1 - 180
7-1. Temperature distributions .....	1 - 180
7-2. Airflow distributions .....	1 - 181
8. OPTIONAL PARTS .....	1 - 182
8-1. Optional parts line up for the Indoor unit .....	1 - 182
8-2. High efficiency filter .....	1 - 182
8-3. Drain pump .....	1 - 182
8-4. Wireless remote controller kit .....	1 - 182

# 1. SPECIFICATIONS

DATA G11

Model		PCFY-P40VKM-E	PCFY-P63VKM-E	PCFY-P100VKM-E	PCFY-P125VKM-E	
Power source		1-phase 220-240V 50Hz, 1-phase 220V 60Hz	1-phase 220-240V 50Hz, 1-phase 220V 60Hz	1-phase 220-240V 50Hz, 1-phase 220V 60Hz	1-phase 220-240V 50Hz, 1-phase 220V 60Hz	
Cooling capacity (Nominal)	*1 kW	4.5	7.1	11.2	14.0	
	*1 kcal / h	3,900	6,100	9,600	12,000	
	*1 BTU / h	15,400	24,200	38,200	47,800	
	*2 kcal / h	4,000	6,300	10,000	12,500	
	(220V) Power input kW	0.04	0.05	0.09	0.11	
(220V) Current input	A	0.28	0.33	0.65	0.76	
Heating capacity (Nominal)	*3 kW	5.0	8.0	12.5	16.0	
	*3 kcal / h	4,300	6,900	10,800	13,800	
	*3 BTU / h	17,100	27,300	42,700	54,600	
	(220V) Power input kW	0.04	0.05	0.09	0.11	
	(220V) Current input	A	0.28	0.33	0.65	0.76
External finish		MUNSELL (6.4Y 8.9/0.4)	MUNSELL (6.4Y 8.9/0.4)	MUNSELL (6.4Y 8.9/0.4)	MUNSELL (6.4Y 8.9/0.4)	
External dimension HxWxD		mm 230x960x680	mm 230x1280x680	mm 230x1600x680	mm 230x1600x680	
		in. 9-1/16 x 37-13/16 x 26-3/4	in. 9-1/16 x 50-3/8 x 26-3/4	in. 9-1/16 x 63 x 26-3/4	in. 9-1/16 x 63 x 26-3/4	
Net weight		kg(lbs) 24(53)	kg(lbs) 32(71)	kg(lbs) 36(79)	kg(lbs) 38(84)	
Heat exchanger		Cross fin (Aluminum fin and copper tube)	Cross fin (Aluminum fin and copper tube)	Cross fin (Aluminum fin and copper tube)	Cross fin (Aluminum fin and copper tube)	
FAN	Type x Quantity		Sirocco fan x 2	Sirocco fan x 3	Sirocco fan x 4	Sirocco fan x 4
	External static press.	Pa	0	0	0	0
		mmH <sub>2</sub> O	0	0	0	0
	Motor Type		DC motor	DC motor	DC motor	DC motor
	Motor output		kW 0.090	kW 0.095	kW 0.160	kW 0.160
	Driving mechanism		Direct-drive	Direct-drive	Direct-drive	Direct-drive
	Air flow rate (Low-Mid2-Mid1-High)	m <sup>3</sup> / min	10-11-12-13	14-15-16-18	21-24-26-28	21-24-27-31
		L/s	167-183-200-217	233-250-267-300	350-400-433-467	350-400-450-517
cfm		353-388-424-459	494-530-565-636	742-847-918-989	742-847-953-1095	
Sound pressure level (measured in anechoic room)		dB <A> 29-32-34-36	dB <A> 31-33-35-37	dB <A> 36-38-41-43	dB <A> 36-39-42-44	
Insulation material		Polyeter sheet	Polyeter sheet	Polyeter sheet	Polyeter sheet	
Air filter		PP honeycomb (long life)	PP honeycomb (long life)	PP honeycomb (long life)	PP honeycomb (long life)	
Protection device		Fuse	Fuse	Fuse	Fuse	
Refrigerant control device		LEV	LEV	LEV	LEV	
Connectable outdoor unit		R410A CITY MULTI	R410A CITY MULTI	R410A CITY MULTI	R410A CITY MULTI	
Diameter of refrigerant pipe	Liquid (R410A)	mm(in.) 6.35(1/4) Flare	mm(in.) 9.52(3/8) Flare	mm(in.) 9.52(3/8) Flare	mm(in.) 9.52(3/8) Flare	
	Gas (R410A)	mm(in.) 12.70(1/2) Flare	mm(in.) 15.88(5/8) Flare	mm(in.) 15.88(5/8) Flare	mm(in.) 15.88(5/8) Flare	
Field drain pipe size		mm(in.) O.D. 26mm(1)	mm(in.) O.D. 26mm(1)	mm(in.) O.D. 26mm(1)	mm(in.) O.D. 26mm(1)	
Drawing	External		-	-	-	-
	Wiring		-	-	-	-
	Refrigerant cycle		-	-	-	-
Standard attachment	Document		Installation Manual, Instruction Book	Installation Manual, Instruction Book	Installation Manual, Instruction Book	Installation Manual, Instruction Book
	Accessory		-	-	-	-
Optional parts	Circular duct flange		-	-	-	-
	Drain pump kit		PAC-SH83DM-E	PAC-SH84DM-E	PAC-SH84DM-E	PAC-SH84DM-E
	Square duct flange		-	-	-	-
	Filter box for rear suction		-	-	-	-
	Filter box for bottom suction		-	-	-	-
	Canvas duct for bottom suction		-	-	-	-
	Medium efficiency filter 65%		-	-	-	-
	High efficiency filter		PAC-SH88KF-E	PAC-SH89KF-E	PAC-SH90KF-E	PAC-SH90KF-E
	Maintenance panel with air intake		-	-	-	-
Wireless remote controller kit		PAR-SL94B-E	PAR-SL94B-E	PAR-SL94B-E	PAR-SL94B-E	
Remarks		* Details on foundation work, duct work, insulation work, electrical wiring, power source switch, and other items shall be referred to the Installation Manual.	* Details on foundation work, duct work, insulation work, electrical wiring, power source switch, and other items shall be referred to the Installation Manual.	* Details on foundation work, duct work, insulation work, electrical wiring, power source switch, and other items shall be referred to the Installation Manual.	* Details on foundation work, duct work, insulation work, electrical wiring, power source switch, and other items shall be referred to the Installation Manual.	

Notes:	*1 Nominal cooling conditions (subject to JIS B8615-1)	*2 Nominal cooling conditions	*3 Nominal heating conditions (subject to JIS B8615-1)	Unit converter
Indoor:	27degC D.B. / 19degC W.B. (81degF D.B. / 66degF W.B.)	27degC D.B. / 19.5degC W.B. (81degF D.B. / 67degF W.B.)	20degC D.B. (68degF D.B.)	kcal/h = kW x 860 BTU/h = kW x 3,412
Outdoor:	35degC D.B. (95degF D.B.)	35degC D.B. (95degF D.B.)	7degC D.B. / 6degC W.B. (45degF D.B. / 43degF W.B.)	cfm = m <sup>3</sup> /min x 35.31 lbs = kg / 0.4536
Pipe length:	7.5 m (24-9/16 ft.)	5 m (16-3/8 ft.)	7.5 m (24-9/16 ft.)	
Level difference:	0 m (0 ft.)	0 m (0 ft.)	0 m (0 ft.)	*The specification data is subject to rounding variation.

PCFY-P40VKM-E

Unit : mm

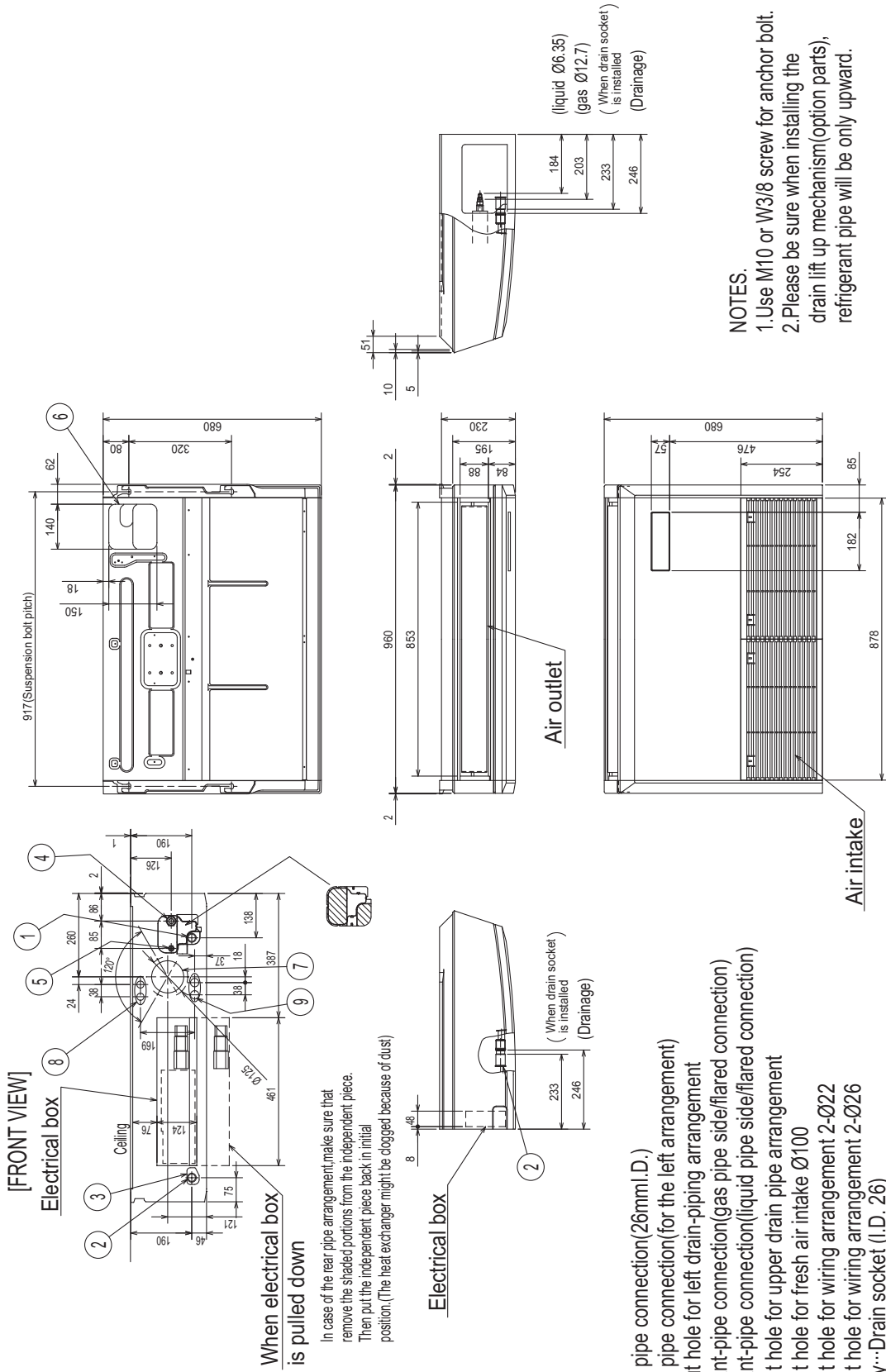

**NOTES.**  
 1. Use M10 or W3/8 screw for anchor bolt.  
 2. Please be sure when installing the drain lift up mechanism (option parts), refrigerant pipe will be only upward.

- ① Drainage pipe connection (26mm I.D.)
  - ② Drainage pipe connection (for the left arrangement)
  - ③ Knock out hole for left drain-piping arrangement
  - ④ Refrigerant-pipe connection (gas pipe side/flared connection)
  - ⑤ Refrigerant-pipe connection (liquid pipe side/flared connection)
  - ⑥ Knock out hole for upper drain pipe arrangement
  - ⑦ Knock out hole for fresh air intake Ø100
  - ⑧ Knock out hole for wiring arrangement 2-Ø22
  - ⑨ Knock out hole for wiring arrangement 2-Ø26
- Accessory... Drain socket (I.D. 26)

PCFY

PCFY-P63VKM-E

Unit : mm

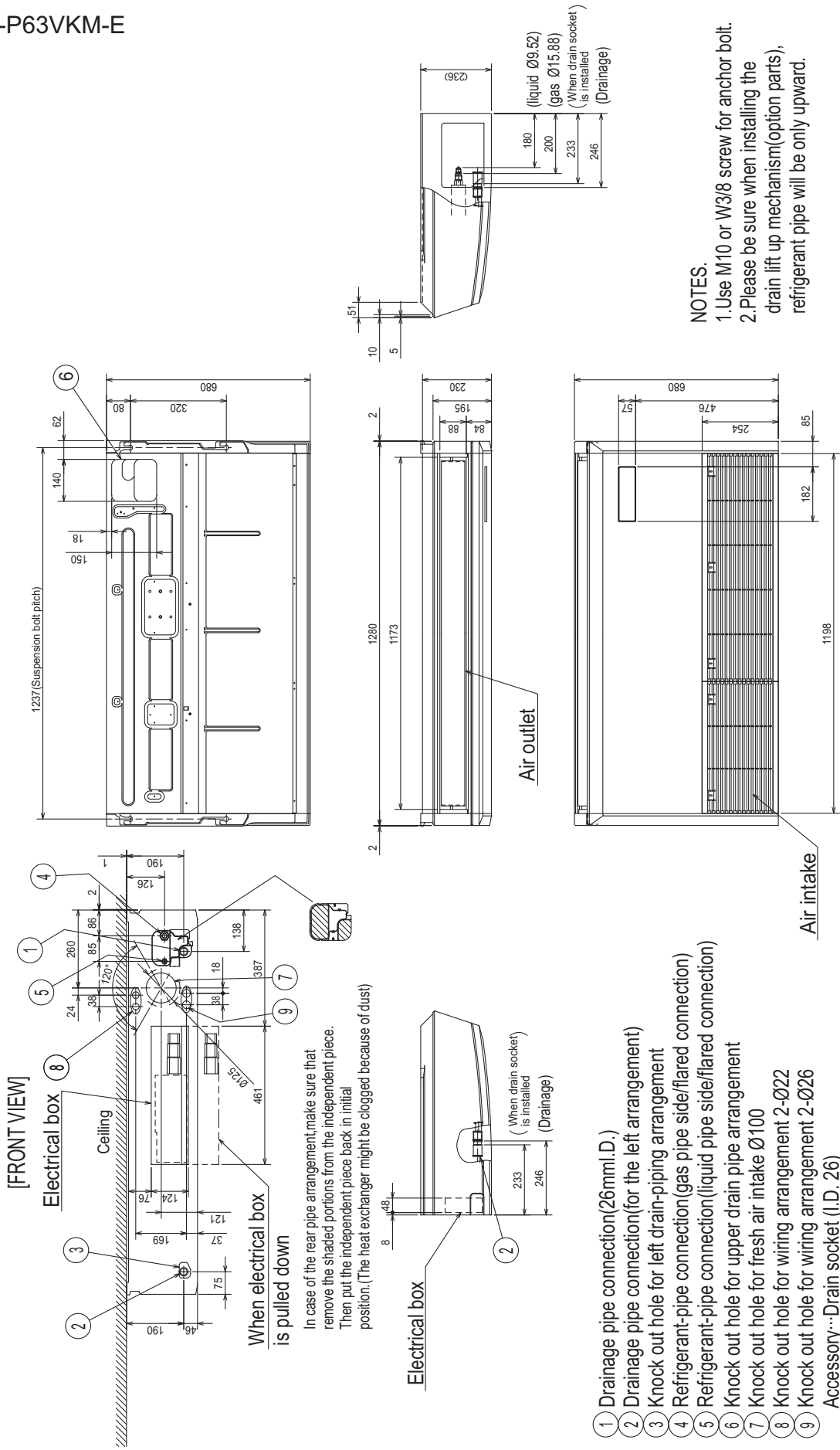

**NOTES.**  
 1. Use M10 or W3/8 screw for anchor bolt.  
 2. Please be sure when installing the drain lift up mechanism (option parts), refrigerant pipe will be only upward.

- ① Drainage pipe connection (26mm I.D.)
  - ② Drainage pipe connection (for the left arrangement)
  - ③ Knock out hole for left drain-piping arrangement
  - ④ Refrigerant-pipe connection (gas pipe side/flared connection)
  - ⑤ Refrigerant-pipe connection (liquid pipe side/flared connection)
  - ⑥ Knock out hole for upper drain pipe arrangement
  - ⑦ Knock out hole for fresh air intake Ø100
  - ⑧ Knock out hole for wiring arrangement 2-Ø22
  - ⑨ Knock out hole for wiring arrangement 2-Ø26
- Accessory... Drain socket (I.D. 26)

PCFY

PCFY-P100,125VKM-E

Unit : mm

- ⑥ Knock out hole for upper drain pipe arrangement
- ⑦ Knock out hole for fresh air intake Ø100
- ⑧ Knock out hole for wiring arrangement 2-Ø22
- ⑨ Knock out hole for wiring arrangement 2-Ø26
- Accessory : Drain socket (I.D. 26)

- ① Drainage pipe connection (26mm I.D.)
- ② Drainage pipe connection (for the left arrangement)
- ③ Knock out hole for left drain-piping arrangement
- ④ Refrigerant-pipe connection (gas pipe side/flared connection)
- ⑤ Refrigerant-pipe connection (liquid pipe side/flared connection)

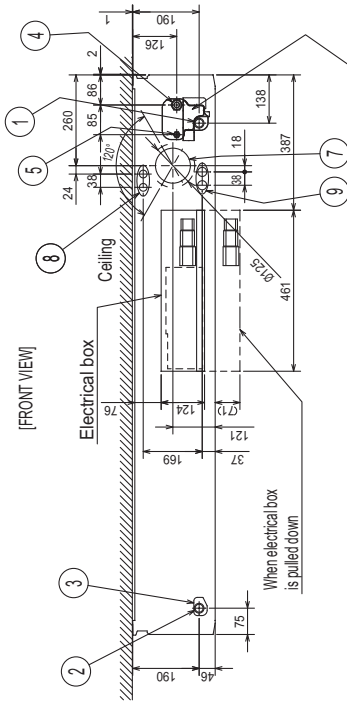

In case of the rear pipe arrangement, make sure that remove the shaded portions from the independent piece. Then put the independent piece back in initial position. (The heat exchanger might be clogged because of dust)

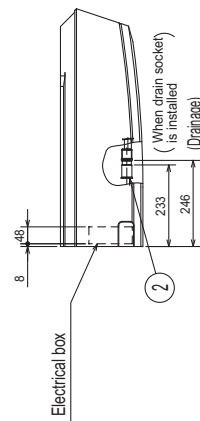
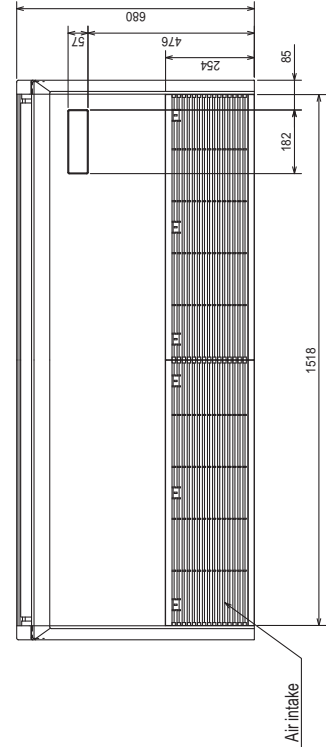
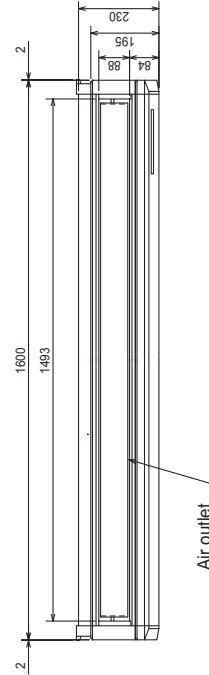
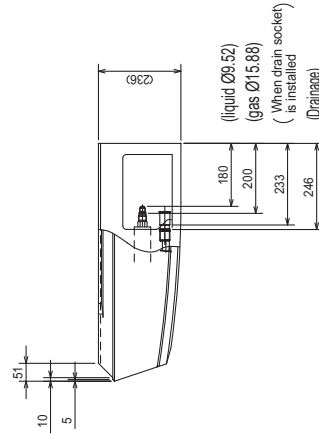

Use the current nuts meeting the pipe size of the outdoor unit.

- NOTES.
1. Use M10 or W3/8 screw for anchor bolt.
  2. Please be sure when installing the drain lift up mechanism (option parts), refrigerant pipe will be only upward.

PCFY-P40,63,100,125VKM-E

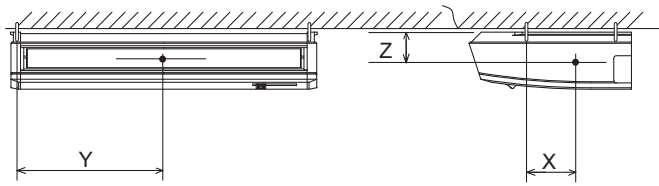

Model name	X	Y	Z
PCFY-P40VKM-E	110	450	115
PCFY-P63VKM-E	110	610	115
PCFY-P100VKM-E	110	770	115
PCFY-P125VKM-E	110	770	115

PCFY-P40, 63, 100, 125VKM-E

[LEGEND]

SYMBOL	NAME	SYMBOL	NAME
I. B	INDOOR CONTROLLER BOARD	TH22	THERMISTOR PIPE TEMP. DETECTION / LIQUID (0°C / 15kΩ, 25°C / 5.4kΩ)
CN27	CONNECTOR DAMPER	TH23	PIPE TEMP. DETECTION / GAS (0°C / 15kΩ, 25°C / 5.4kΩ)
CN32	CONNECTOR REMOTE SWITCH	A. B	ADDRESS BOARD
CN51	CONNECTOR CENTRALLY CONTROL	SWA	SWITCH CEILING HEIGHT SELECTOR
CN52	CONNECTOR REMOTE INDICATION	SWC	SWITCH OPTION SELECTOR
CN105	CONNECTOR IT TERMINAL	SW1	SWITCH MODE SELECTION
FUSE	FUSE (T6.3AL250V)	SW11	SWITCH ADDRESS SETTING 1s DIGIT
SW2	SWITCH CAPACITY CODE	SW12	SWITCH ADDRESS SETTING 10ths DIGIT
SW3	SWITCH MODE SELECTION	SW14	SWITCH BRANCH No.
SW4	SWITCH MODEL SELECTION	OPTIONAL PARTS	
SWE	SWITCH DRAIN PUMP (TEST MODE)	W. B	PCB FOR WIRELESS REMOTE CONTROLLER
X1	AUX. RELAY DRAIN PUMP (OPTIONAL PARTS)	BZ	BUZZER
LEV	LINEAR EXPANSION VALVE	LED1	LED (OPERATION INDICATION : GREEN)
DCL	REACTOR	LED2	LED (PREPARATION FOR HEATING : ORANGE)
MF	FAN MOTOR	RU	RECEIVING UNIT
MV	VANE MOTOR	SW1	SWITCH EMERGENCY OPERATION (HEAT / DOWN)
TB2	TERMINAL BLOCK POWER SUPPLY	SW2	SWITCH EMERGENCY OPERATION (COOL / UP)
TB5	TERMINAL BLOCK TRANSMISSION	DP	DRAIN PUMP
TB15	TERMINAL BLOCK MA-REMOTE CONTROLLER	FS	DRAIN FLOAT SWITCH
TH21	THERMISTOR ROOM TEMP. DETECTION (0°C / 15kΩ, 25°C / 5.4kΩ)		

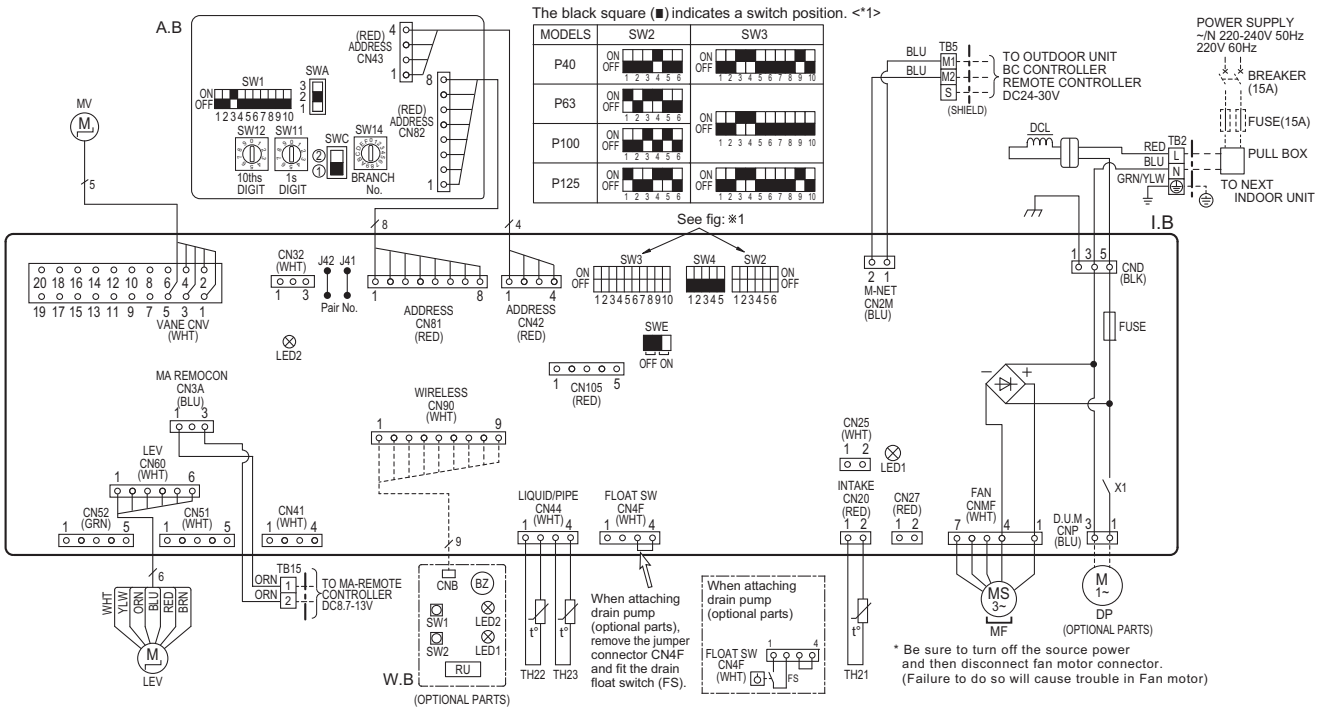

NOTES:

- At servicing for outdoor unit, always follow the wiring diagram of outdoor unit.
- In case of using MA-Remote controller, please connect to TB15.  
(Remote controller wire is non-polar.)
- In case of using M-NET, please connect to TB5. (Transmission line is non-polar.)
- Symbol [S] of TB5 is the shield wire connection.
- Symbols used in wiring diagram above are, [ ] : terminal block, [ ] : connector.
- The setting of the SW2 dip switches differs in the capacity. For the detail, refer to fig <\*1>.

LED on indoor board for service

Mark	Meaning	Function
LED1	Main power supply	Main Power supply (Indoor unit:220-240V) power on → lamp is lit
LED2	Power supply for MA-Remote controller	Power supply for MA-Remote controller on → lamp is lit

PCFY

5-1. Sound levels

Ceiling suspended

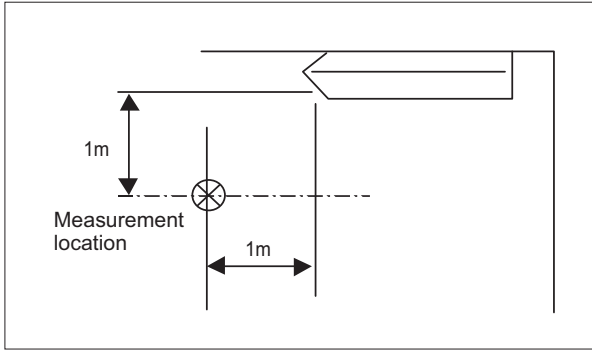

Sound level at anechoic room : Low-Middle2-Middle1-High

Model	Sound level dB (A)
PCFY-P40VKM-E	29-32-34-36
PCFY-P63VKM-E	31-33-35-37
PCFY-P100VKM-E	36-38-41-43
PCFY-P125VKM-E	36-39-42-44

\* Measured in anechoic room.

5-2. NC curves

PCFY-P40VKM

External Static Pressure: 0Pa  
Power Source: 200V, 50/60Hz

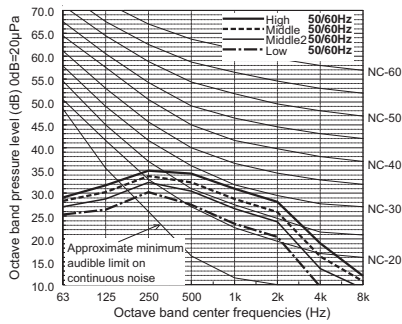

PCFY-P63VKM

External Static Pressure: 0Pa  
Power Source: 200V 50/60Hz

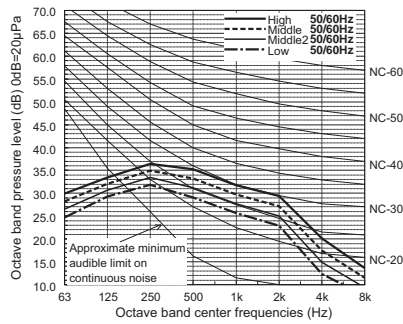

PCFY-P100VKM

External Static Pressure: 0Pa  
Power Source: 200V 50/60Hz

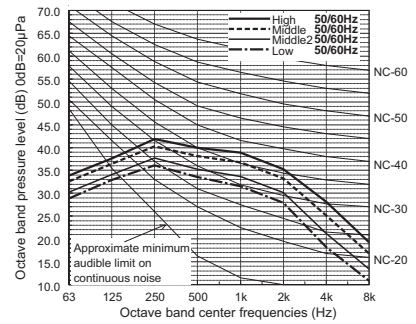

PCFY-P125VKM

External Static Pressure: 0Pa  
Power Source: 200V 50/60Hz

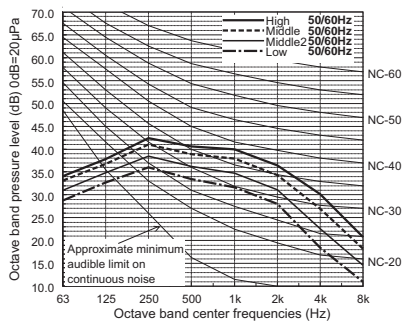

PCFY



■ PCFY-P40VKM-E



■ PCFY-P63VKM-E



■ PCFY-P100, 125VKM-E

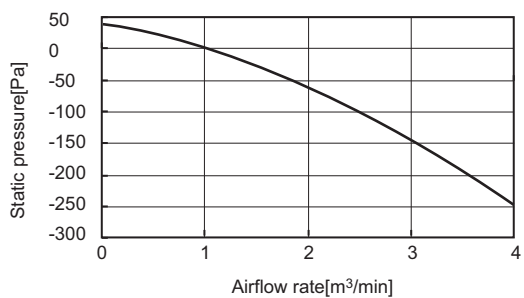

7-1. Temperature distributions

Temperature distributions

PCFY-P40, 63VKM-E

<Cooling mode>

Flow angle : 10°  
 Temperature setting : 27°C  
 High notch

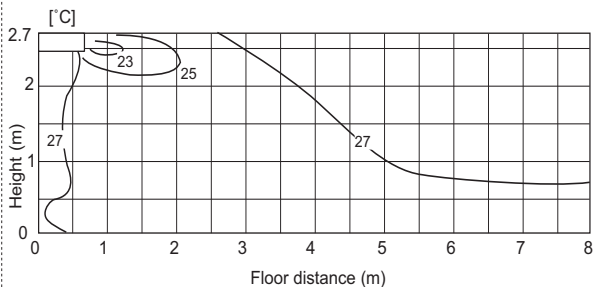

<Heating mode>

Flow angle : 60°  
 Temperature setting : 20°C  
 High notch

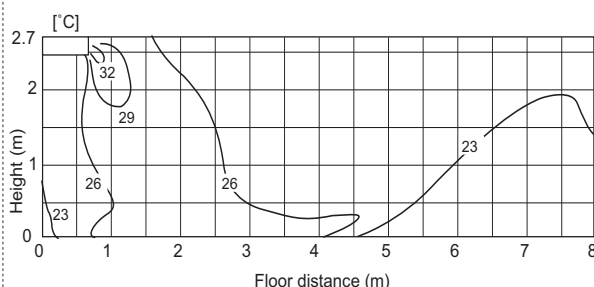

PCFY-P100, 125VKM-E

<Cooling mode>

Flow angle : 10°  
 Temperature setting : 27°C  
 High notch

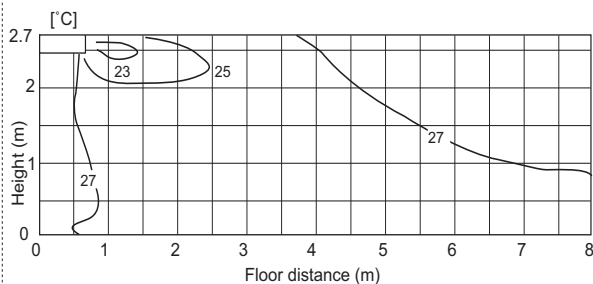

<Heating mode>

Flow angle : 60°  
 Temperature setting : 20°C  
 High notch

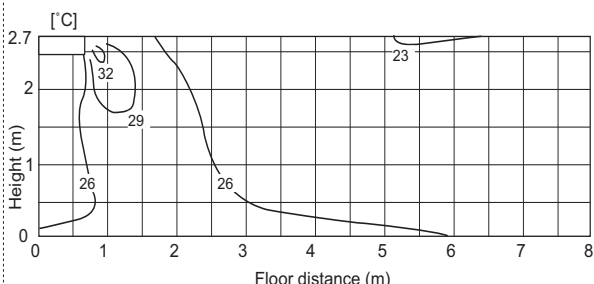

Note : These figures show typical airflow distributions in the conditions above. In the actual installation, they may differ from these figures under the influence of air temperature conditions, ceiling height, cooling/heating load, obstacles, etc.

7-2. Airflow distributions

**Airflow distributions  
PCFY-P40, 63VKM-E**

**<Cooling mode>**

Flow angle : 10°  
Temperature setting : 27°C  
High notch  
Ceiling height : 2.7m

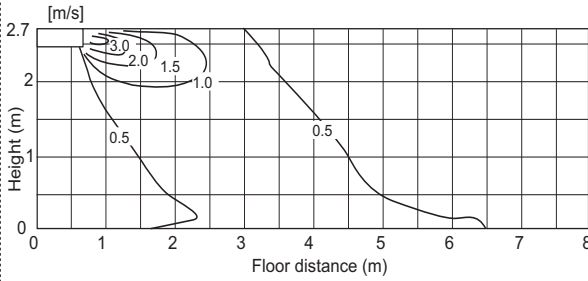

**<Heating mode>**

Flow angle : 60°  
Temperature setting : 27°C  
High notch  
Ceiling height : 2.7m

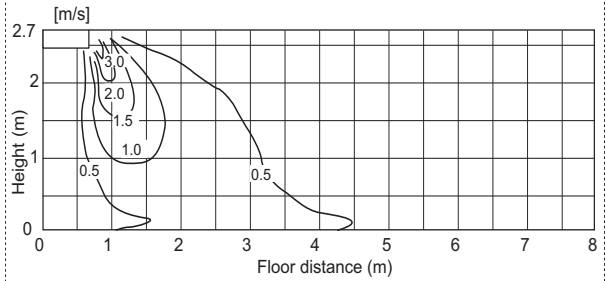

**PCFY-P100, 125VKM-E**

**<Fan mode>**

Flow angle : 10°  
Temperature setting : 27°C  
High notch  
Ceiling height : 2.7m

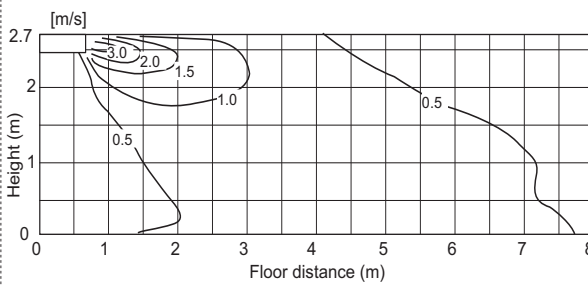

**<Fan mode>**

Flow angle : 60°  
Temperature setting : 27°C  
High notch  
Ceiling height : 2.7m

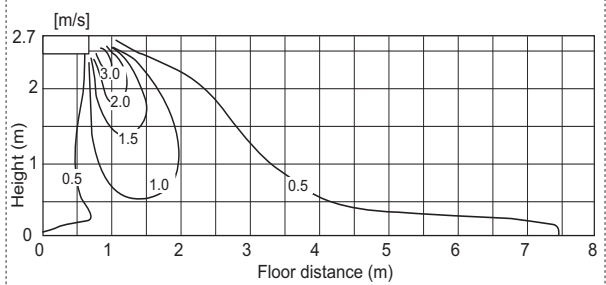

Note : These figures show typical airflow distributions in the conditions above. In the actual installation, they may differ from these figures under the influence of air temperature conditions, ceiling height, cooling/heating load, obstacles, etc.

## 8-1. Optional parts line up for the Indoor unit





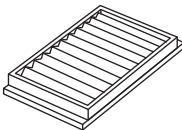



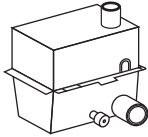
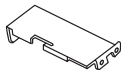

	High-efficiency filter	Wireless remote controller kit	Drain pump
PCFY-P40VKM-E	PAC-SH88KF-E	PAR-SL94B-E	PAC-SH83DM-E
PCFY-P63VKM-E	PAC-SH89KF-E	PAR-SL94B-E	PAC-SH84DM-E
PCFY-P100,125VKM-E	PAC-SH90KF-E	PAR-SL94B-E	PAC-SH84DM-E

## 8-2. High efficiency filter

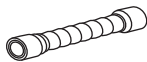
Material: PP honeycomb Gravimetric method: 70%			
Item	PAC-SH88KF-E	PAC-SH89KF-E	PAC-SH90KF-E
Quantity	2 (Small)	1 (Small), 2 (Large)	2 (Large)
Shape			

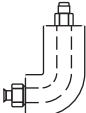
## 8-3. Drain pump

If drain water can not flow out the Indoor unit by gravity and gradient, a Drain-pump for draining is needed.  
Drain pump PAC-SH-DM-E can pump water up to 600 mm high from the ceiling.

Item	① Drain lift up mechanism	② Attachment	③ Screws (4×10)	④ VP-20 pipe	⑤ Pipe cover
Quantity	1	1	6	1	1
Shape		 1 Drain lift up mechanism fixture	 For the installation of drain lift up mechanism 1		 For insulation of VP20 pipe4
Item	⑥ Flexible hose	⑦ Fastener	⑧ L-shaped pipe (gas pipe)	⑨ L-shaped pipe (liquid pipe)	⑩ Insulator A
Quantity	1	1	1	1	2
Shape					6t×220×80 (For internal insulation)  For the insulation of L-shaped pipes ⑧ and ⑨ and the refrigerant pipes.
Item	⑪ Insulator B				
Quantity	2				
Shape	3t×250×120 (For external insulation)  For the insulation of L-shaped pipes ⑧ and ⑨ and the refrigerant pipes.				

Detailed installation information should be referred to its Installation Manual.

## 8-4. Wireless remote controller kit

Wireless remote controller receiver is built-in type.

Item	① Wireless remote controller receiver	② Wireless remote controller	③ Remote control holder	④ "AAA" LR3 alkaline batterie	⑤ 4.1 x 16 wood screw
Quantity	1	1	1	2	2
Item	⑥ Cord retaining clips	⑦ Connection cord fixing seal (12x30 size)			
Quantity	2	1			

Detailed installation information should be referred to its Installation Manual.